

X135

HD 720p Driving Recorder

Quick Start Guide

Product specifications and features are for reference only and are subject to change without prior notice.

X135

1 Introduction

1.1 Package Contents

The package contains the following items. In case there is any missing or damaged item, contact your dealer immediately.

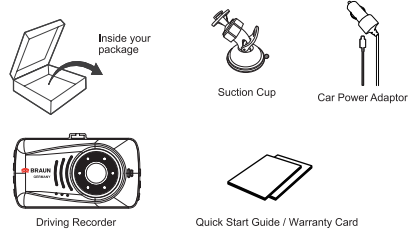

1.2 Product Overview

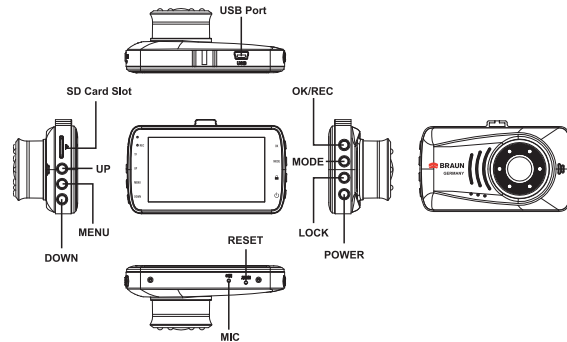

EN-2

2 Getting Started

2.1 Inserting the Memory Card

Follow the direction indicated by the silk printing on the device to insert the memory card, a click sound is heard indicating the card is in position. (not included)

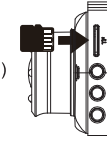

To remove the memory card, push to eject the memory card out of the slot.

Note:

- Do not remove or insert the memory card when the device is turned on. This may damage the memory card.
- Please use a Class 10 or higher rating Micro SD card, max. up to 32GB.
- Please format the micro SD card before the initial use.
- When removing the memory card, be careful that the card may spring out and get lost. The memory slot has this spring-out feature for easy removal of the card.

2.2 Installing in Vehicles

→ Push the head of the mount into the device slot, make sure the mount is securely locked in place.



EN-3

X135

X135

→ Remove the protective film from the suction cup, with the suction-cup laying flat, position the suction-cup on the windshield, and then press down the clamp to mount the holder to the windshield. Make sure the base is securely locked in place.

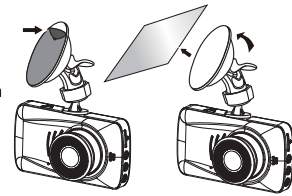

→ Loosen the knob to swivel the device vertically. Locking knob, and confirm that the device is securely locked in place.

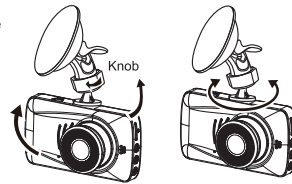

→ Rotating the device to have proper view.

2.3 Connecting to Power

Use only the attached car power adaptor for activating the device and charging the built-in battery.

1. Connect one end of power connector to USB port on the device.

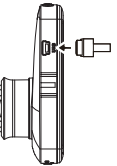

2. Plug the other end of the power adaptor to the cigarette lighter socket of your vehicle. Once the vehicle engine is started, the device automatically turns on.

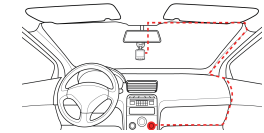

EN-4

X135

2.4 Powering the Device On / Off and Reset

2.4.1 Auto Power On / Off

Once the vehicle engine is started, the device automatically turns on and recording (must have SD Card). After the car engine stopped, the device will automatically save the last recorded file and shutdown.

2.4.2 Manual Power On / off

Press [POWER] to turn it on. To power off the device press [POWER] with 3 seconds again.

2.4.3 Reset the Device

In case the device fails to function normally due to unknown causes, please use a pin to poke the [RESET] hole, then press [POWER] to restart the device.

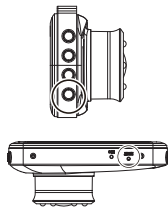

2.5 Set the Date / Time

To set the correct date and time, press [MENU] to enter the menu setting mode, then press [UP] / [DOWN] to select Date/Time, press [OK] enter date /time setting, then press [UP] / [DOWN] to adjust the value, press [OK] switch to next setting, after finished all the settings, press [OK] to back menu setting, then press [Menu] to exit from menu setting.

2.6 A Key Protection

During recording, press [LOCK] to protect current video, the lock icon  appears on the screen, the current movie clip will be protected and cannot be replaced, the next movie clip will unlock automatically and can be replaced if the SD card is full.

EN-5

X135

2.7 Audio On / Off

During recording, press [DOWN] can turn Off / On the audio.

3 Playback and media connection

3.1 Playback mode

In preview mode, press [MODE] twice to enter playback mode.

- Press [UP] / [DOWN] to scroll through the files.
- Press [OK] to start /stop playback.
- Press [MODE] twice again to exit playback mode.

Note:

While viewing the file list, you can press [MENU] to select to:

- Delete one file or all the files.
- Protect/lock or unprotect/unlock one file or all the files.

3.2 Connect to your PC

a) In order to view recorded video on Computer, please remove memory card from DVR and using a SD card reader (not included), insert into a computer. Files can be viewed in the same way as a digital camera.

b) Connect the camera to computer using a USB cable (not included). Files can be viewed in the same way as a digital camera.

EN-6

X135

4 Technical specifications

LCD display	3.0" color TFT screen
Image sensor	1 Mega Pixels CMOS Sensor
View angle	110°
Video resolution	1280×720 30fps 1920×1080 30fps (interpolated)
Picture resolution	2M (Interpolated)
Video format	AVI
Picture format	JPG
Memory	Support Class 10 or higher rating Micro SD card, maximum up to 32GB.
Microphone	Built-in
Speaker	Built-in
G-sensor	Yes
Power source	Built-in battery, car power adaptor
Interface	USB port, SD card slot
Operating temperature	0°~ 45° C
Input	5V --- 1.0A
Dimensions	89.0 x 54.0 x 34.3mm
Weight	88.0g

EN-7

5 Cautions

Please read all safety precautions before using the device.

- Make sure that the lens is within the wiping range of the windshield wiper to ensure a clear view even when it rains.
- A protective film on the lens will affect the video or photographic effect, remove the protective film before using the device.
- Do not touch the lens with your fingers. Finger grease may be left on the lens and will result in unclear videos or snapshots. Clean the lens on a regular basis.
- Make sure that the installation position is not hindered by the tinted window.
- Use the contained car power adaptor only. In order to avoid equipment burn or cause the battery explosion, please do not use other brand car power adaptor.
- Due to local laws and vehicles safety considerations, do not operate the device while driving.
- Set up time and date accurately before you use this device.
- This product gets warm when in use, this is normal.
- Do not place the device near a heat source or directly expose it to flame or heat.
- Never place the device in vicinity of equipment generating strong electromagnetic fields. Exposure to strong magnetic fields may cause malfunctions or data corruption and loss.
- The system is used only for non-commercial use, within the maximum limits permitted by applicable law. Our company does not accept any responsibility for any data loss during the operation.
- Improper use or operation of the product may result in damage of the product or its accessories and void the warranty.

Before you start using the system, it is assumed that you agree to the above statement.

EN-8